



bank

Goteborg



In vele kleuren & materialen leverbaar



In vele afmetingen & opstellingen mogelijk



Keuze uit diverse pootjes (ook in hoogte)



Verkrijgbaar met relaxfunctie 



ACCU voor relaxfunctie (geen snoer nodig)



ARM1



ARM2



ARM3



ARM4



ARM5



ARM9



Texas (2) - Caramel



Texas (2) - Dark Brown



Kentucky (3) - Liver



Soleda (L) - Pure White

In showroom

en nog is 200 opties!

Opstellingen & afmetingen

Aan de hand van de onderstaande elementen kun u uw ideale opstelling samenstellen. De elementen bestaan uit verschillende zitbreedtes.

Let op: Bij gebruik van een  relaxfunctie zult u altijd met de 1 zits (Cxx) moeten werken.

Aangegeven afmetingen kunnen afwijken i.v.m. stoffering hou **CA. 1 cm per element aan.**

Alle elementen zijn exclusief armleuningen. Deze dienen erbij opgeteld te worden. Keuze uit 6 armleggers. (zie blad Armleggers)



Relaxfunctie met touch sensors
(0-wall - Bank kan dicht bij de muur staan)



Accu voor relaxfunctie
(geen snoer nodig - opladen 6 uur)

1 zit

(zonder armen)

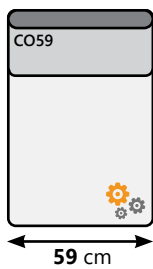

2 zit

(zonder armen)

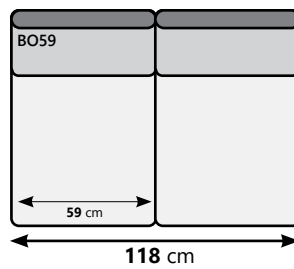

1,5 zit

(zonder armen)



2,5 zit

(zonder armen)

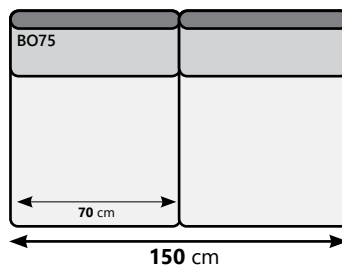

1,5 zit

(zonder armen)



3 zit

(zonder armen - met 2 zitkussens)

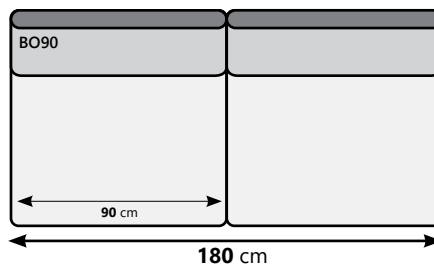

3 zit

(zonder armen - met 3 zitkussens)

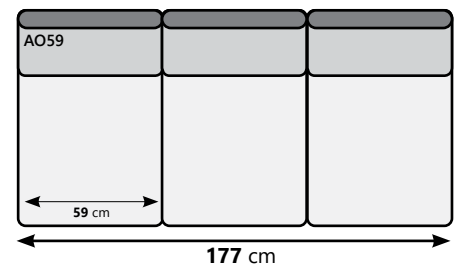

Hoek

(Afgesneden hoek - Rond)

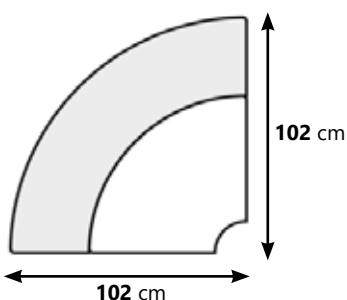

1 zit met hocker Rechts

(zitting met open einde)

1 zit met hocker Links













(zitting met open einde)



bank

Goteborg

Armleggers

					
Arm 1 AR1V AR1H B x H x D	Arm 2 AR2V AR2H B x H x D	Arm 3 AR3V AR3H B x H x D	Arm 4 AR4V AR4H B x H x D	Arm 5 AR5V AR5H B x H x D	Arm 9 AR9V AR9H B x H x D
15 62 90	24 62 90	15 62 90	27 59 93	19 59 90	25 59 90
					









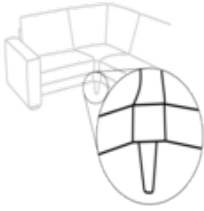

bank

Goteborg

Poot mogelijkheden

200 mm	Type 015 10,5 cm		
			
160 mm	Type 154 2,50 cm	Type 180 2,50 cm	Type 1D6 2,50 cm
			
Diverse hout kleuren mogelijk.	JA	JA	JA

Hout kleur opties:

- Beuken gelakt
- Beuken onbehandeld
- Eiken onbehandeld
- Eiken gelakt
- Eiken geolied
- Beuken zwart
- Eiken wit geolied
- Beuken donkerbruin
- Beuken bruin
- Beuken noten gelakt
- Noten gelakt
- Noten geolied



Voorbeelden

Let op: Alle afmetingen zijn **ARM1**

2,5 zit + Relax
(ARM1L + CO75+R + CO75+ ARM1R)

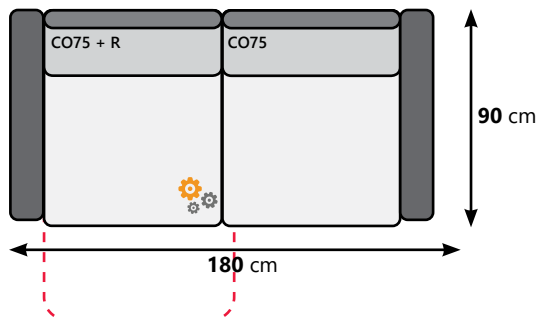

Fauteuil
(ARM1L + CO59 + ARM1R)

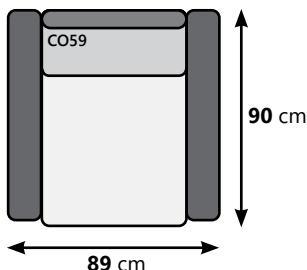

2 zit
(ARM1L + BO59 + ARM1R)

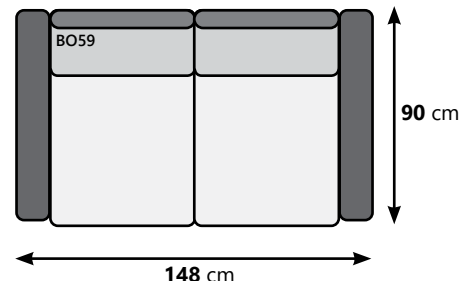

Grote bank met 4 zitkussens
(ARM1L + BO75 + BO75 + ARM1R)

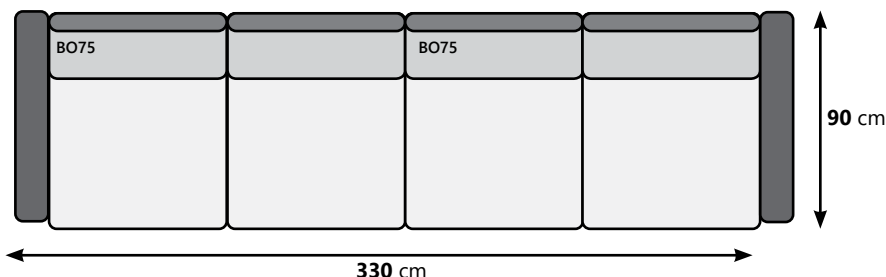

Loveseat incl Relax
(ARM1L + CO90+R + ARM1R)

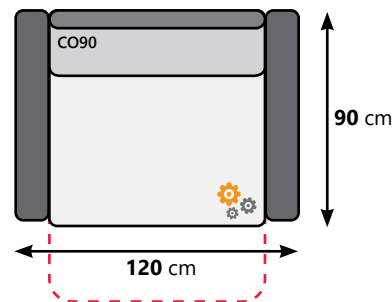

Hoekbank
(X65H + THJ + BO75 + ARM1R)

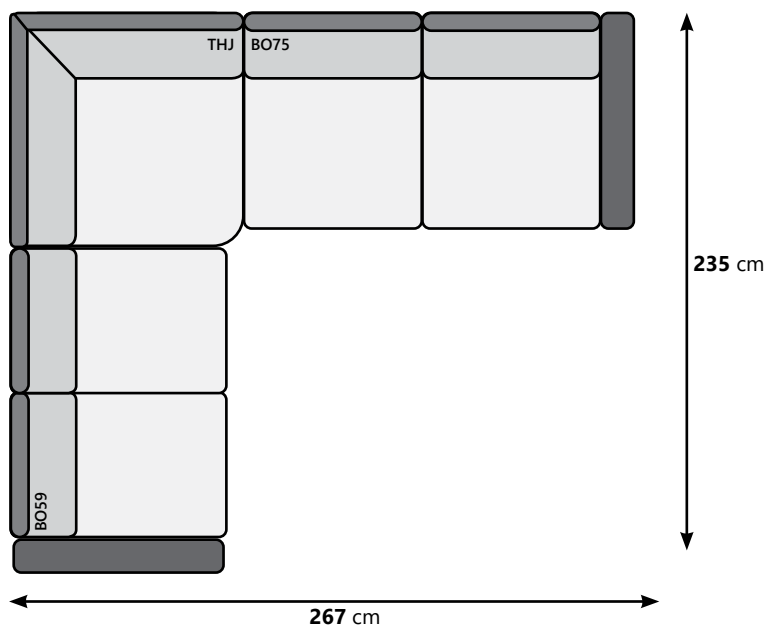

3 zit met 3 zitkussens
(ARM1L + AO59 + ARM1R)

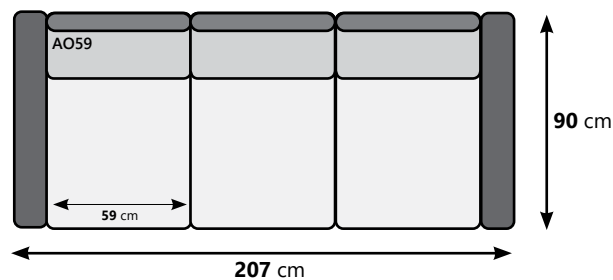

G. Rietveldweg 3
Heerhugowaard

072 – 5741160

info@brouwermeubelen.nl

brouwermeubelen.nl

Openingstijden

Maandag
Dinsdag
Woensdag
Donderdag
Vrijdag
Zaterdag
Zondag

12:00 uur – 17:30 uur
09:00 uur – 17:30 uur
09:00 uur – 17:30 uur
09:00 uur – 17:30 uur
09:00 uur – 17:30 uur
10:00 uur – 17:00 uur
Gesloten

